

Datasheet - MV8H 330-11Y



Position switch / light Position switch / M 330 / M 330 Roller lever 8H



- Metal enclosure
- Long life
- 40 mm x 76 mm x 40 mm (basic component)
- Suitable for low actuating speeds
- 1 Cable entry M 20 x 1.5
- free of silicon
- proved in power station applications
- Actuator head can be repositioned in steps 4 x 90°
- Continuous adjustment of lever position 360°
- Lever can be transposed by 180°

(Minor differences between the printed image and the original product may exist!)

Ordering details

Product type description	MV8H 330-11Y
Article number	1167334
EAN code	4030661218847

Global Properties

Product name	330 Rollenschwenkhebel 8H
Standards	EN 60947-5-1
Compliance with the Directives (Y/N) 	Yes
Suitable for safety functions (Y/N)	No
Standard housing (Y/N)	No
Materials	
- Material of the housings	cast iron
- Roller material	Plastic
- Material of the contacts	Silver
Housing coating	painted
Weight	277 g
Slide form	Castor

Mechanical data

Design of electrical connection	Screw connection
Cable section	
- Min. Cable section	1.5 mm ²

- Max. Cable section	2.5 mm ²
AWG-Number	13
Active principle	mechanical
Mechanical life	> 30.000.000 operations
Design of actuating element	Roller lever
actuating torque	50,5 Ncm
restistance to shock	50 g / 6 ms
Bounce duration	≤ 1.5 ms
Switchover time	≤ 10 ms
Contact opening	2 x 0,5 mm
Repeat accuracy of switching points	± 0,02 mm
Actuating speed	
- Min. Actuating speed	1 mm/min
- Max. Actuating speed	
notice	All indications about the cable section are including the conductor ferrules.

Ambient conditions

Ambient temperature	
- Min. environmental temperature	- 30°C
- Max. environmental temperature	+ 90°C
Protection class	IP65 to IEC/EN 60529

Electrical data

Design of control element	Normally open contact (NO), Opener (NC)
- Change-over contact with double break	
- galvanically separated contact bridges	
Switching principle	Snap switch element
Number of shutters	1 piece
Number of openers	1 piece
Rated impulse withstand voltage U_{imp}	4 kV
Rated insulation voltage U_i	250 V
Thermal test current I_{the}	6 A
Utilisation category	AC-15: 230 V / 2,5 A
Max. fuse rating	6 A gG D-fuse

Dimensions





Dimensions of the sensor	
- Width of sensor	40 mm
- Height of sensor	129.5 mm
- Length of sensor	40 mm
Roller wide	8.5 mm
Roller diameter	20 mm

Diagram



Note Diagram



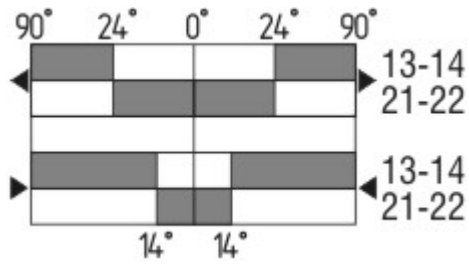

⊙ → positive break NC contact

-  active
-  no active
-  Normally-open contact
-  Normally-closed contact

Switch travel diagram



Notes Switch travel diagram

-  Contact closed
-  Contact open
-  Setting range
-  Break point
-  Positive opening sequence/- angle
- VS** adjustable range of NO contact
- VÖ** adjustable range of NC contact
- N** after travel

Ordering suffix

The applicable ordering suffix is added at the end of the part number of the safety switch.
Order example: MV8H 330-11Y**Au-Ni**

... Au-Ni	Gold-nickel contact tips for low DC votages
... -RMS	Available with metal roller
...- 1164	Splined shaft and lever available with 10° toothing
...- A	actuating torque 24 Ncm

Ordering code

M(1) 330-11Y-(2)-(3)

(1)

- S** Plunger S
- 2S** Telescopic plunger 2S
- R** Roller plunger R
- K** Offset roller lever K
- 3K** Angle roller lever 3K
- 3S** Side plunger 3S
- 3R** Side roller plunger 3R
- AF** Spring rod lever AF
- 4D** Forked roller lever 4D

- 8H** Roller lever 8H
- 7H** Roller lever 7H
- 10H** Rod lever 10H
- H** Roller lever H
- 4H** Spring rod lever on shaft 4H
- 2H** Leaf-spring lever 2H
- 3H** Roller lever 3H
- 9H** Rod lever 9H
- 6H** Leaf-spring lever 6H

(2)

without without LED switching conditions display

G24 with LED switching conditions display

(3)

Ni Contacts in Gold-nickel alloy

1164 Splined shaft and lever available with 10° tothing

1366 For temperatures up to +160°C

Documents

Mounting and wiring instructions (de, en, fr) 145 kB, 31.03.2008

http://www.schmersal.net/Bilddata/Posi/Pdf/M330/montage/m_330p01.pdf

Declaration of conformity (de, en) 76 kB, 03.09.2002

http://www.schmersal.net/Bilddata/Posi/Pdf/M330/konform/___330p01.pdf

Images

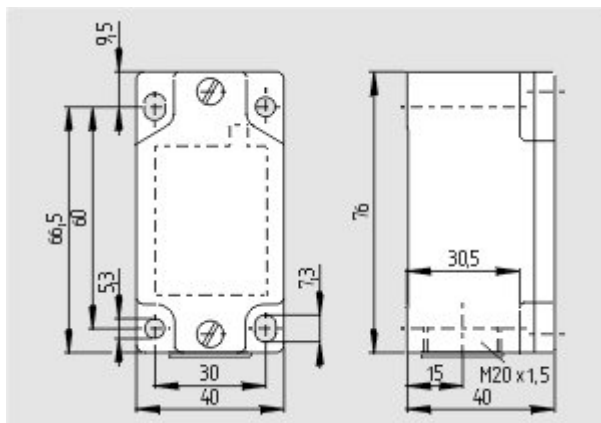

Dimensional drawing (basic component)

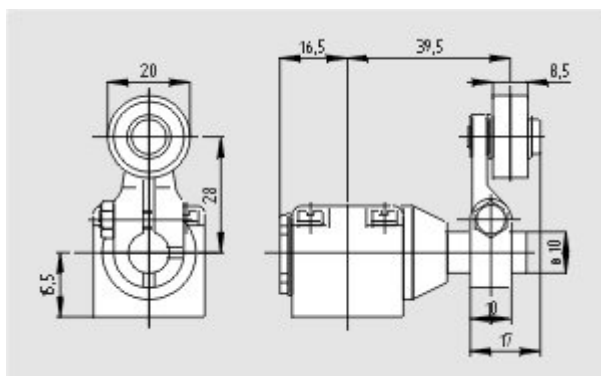

Dimensional drawing (miscellaneous)

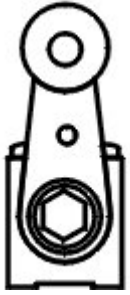

Operating principle

K.A. Schmersal GmbH, Möddinghofe 30, D-42279 Wuppertal
The data and values have been checked thoroughly. Technical modifications and errors excepted.
Generiert am 29.03.2010 - 17:59:41h Kasbase 1.3.5 DBI